

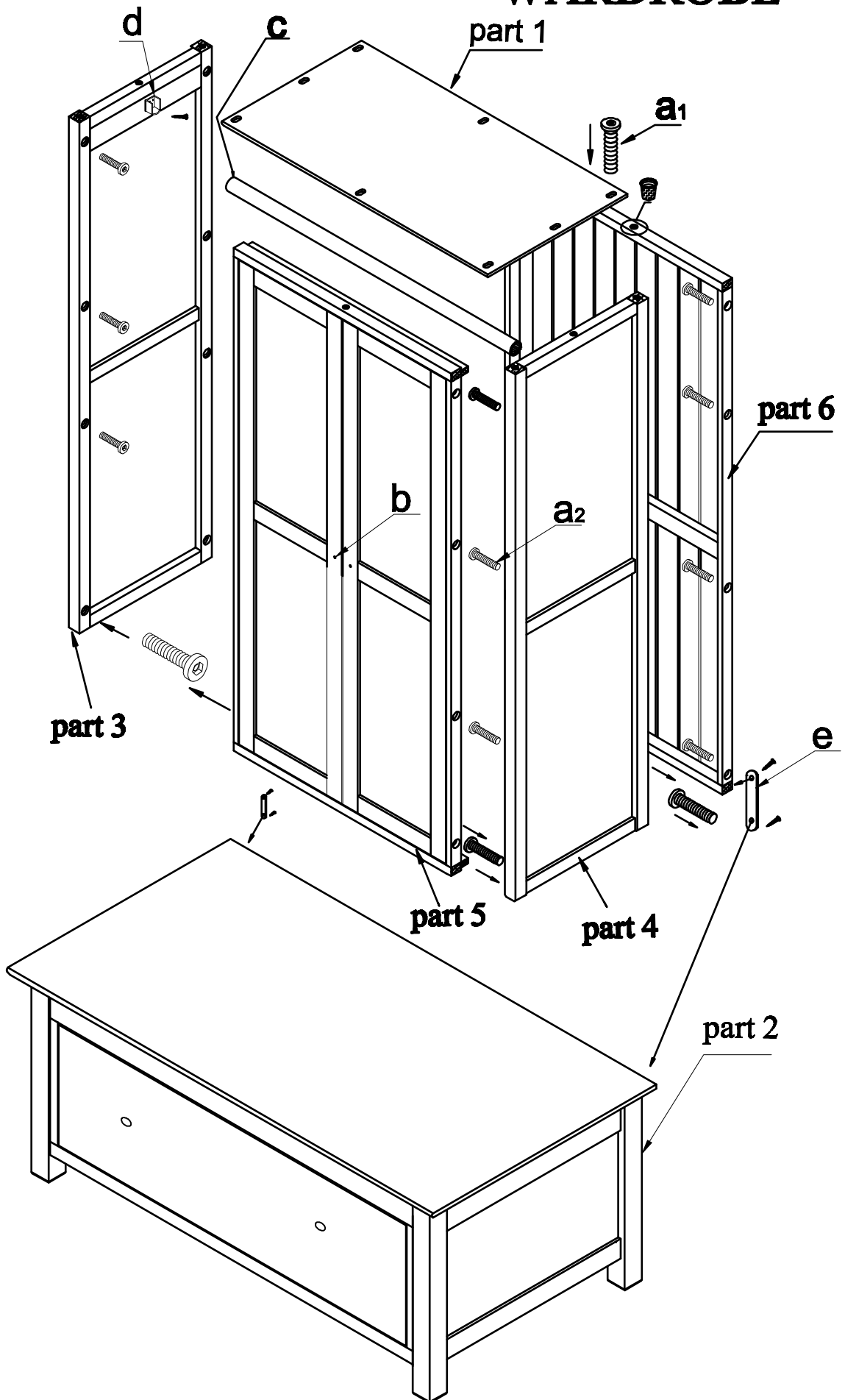

TO -GENTS 1 DRAWER WARDROBE

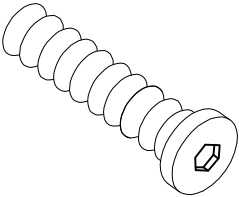
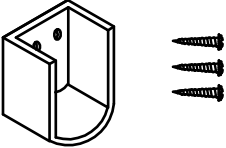
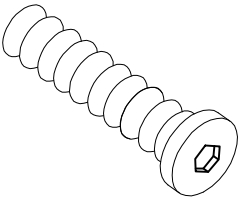
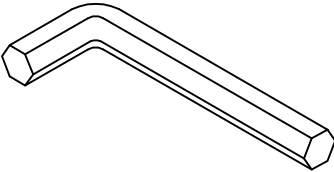
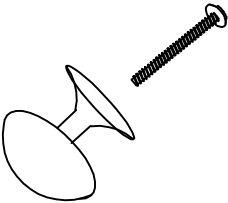
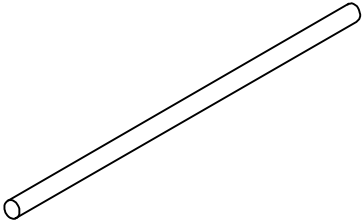
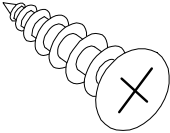

FITTINGS

GENTS 1 DRAWER WARDROBE	
<p>Hexa Bolt</p>  <p>$\varnothing 6 \times 35$ $a1 \times 8$</p>	<p>Clothes Hook</p>  <p>$dx2$</p>
<p>Hexa Bolt</p>  <p>$\varnothing 6 \times 35$ $a2 \times 16$</p>	<p>Hexa Wrench</p>  <p>$\times 1$</p>
<p>Handle</p>  <p>$b \times 2$</p>	<p>Iron Sheet</p>  <p>$e \times 2$</p>
<p>Hanging Rail</p>  <p>L $c \times 1$</p>	<p>Screw</p>  <p>$\varnothing 3.5 \times 20$ $\times 6$</p>